



Idaho National Laboratory

Liquid-Liquid Extraction Equipment

Jack Law
Idaho National Laboratory

Introduction to Nuclear Chemistry and Fuel Cycle
Separations
Las Vegas
July 2011

Outline

- **Introduction**
 - **Role of separations equipment in the nuclear fuel cycle**
 - **Solvent extraction basic principles**
- **Solvent Extraction Equipment**
 - **Mixer-settlers**
 - **Columns**
 - **Centrifugal contactors**
- **Comparison of Equipment**
- **Summary**

Introduction

- **Liquid-liquid extraction is widely used in fuel cycle facilities in the nuclear industry**
 - France
 - United Kingdom
 - Japan
 - Russia
 - Previously in the United States

- **Used to separate reusable components from used nuclear fuel (i.e., uranium)**

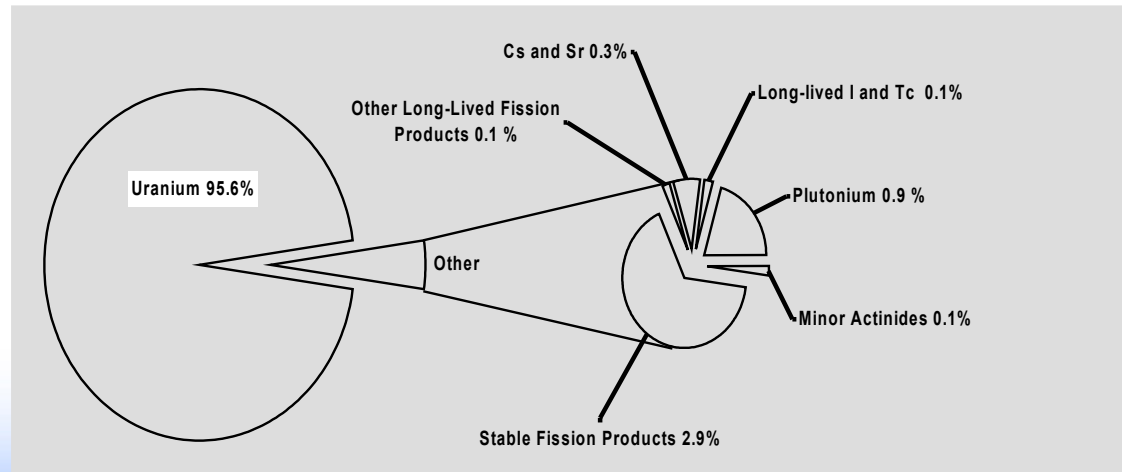

Solvent Extraction Basic Principles

Extraction

Scrubbing

Stripping

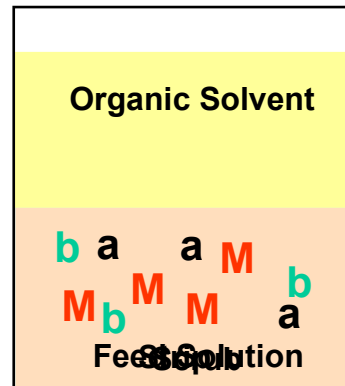

Separates metal to be recovered

Removes impurities from metal

Recovers product in solution

Countercurrent Flow

- A liquid-liquid extraction process in which the solvent and the process stream in contact with each other flow in opposite directions
- Efficient separation is achieved through countercurrent flow in solvent extraction equipment

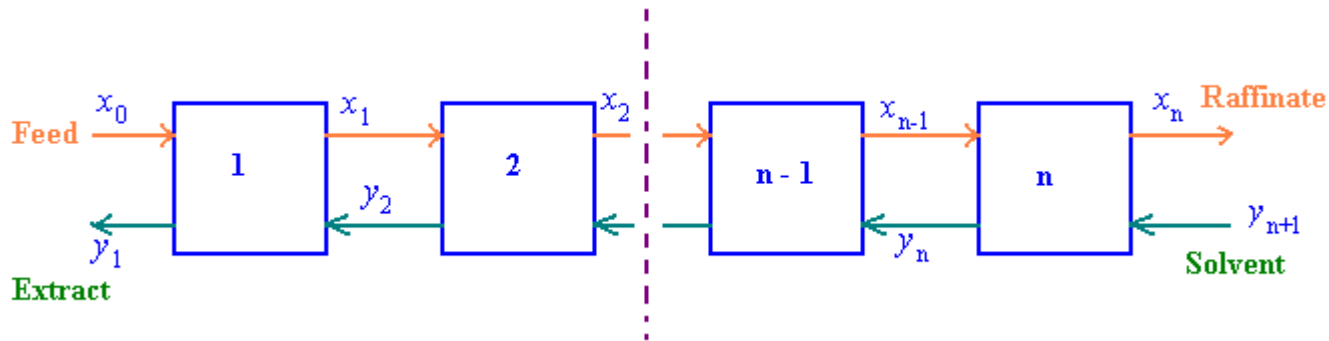

Distribution

$$\text{Coefficient (D)} = y_n/x_n$$

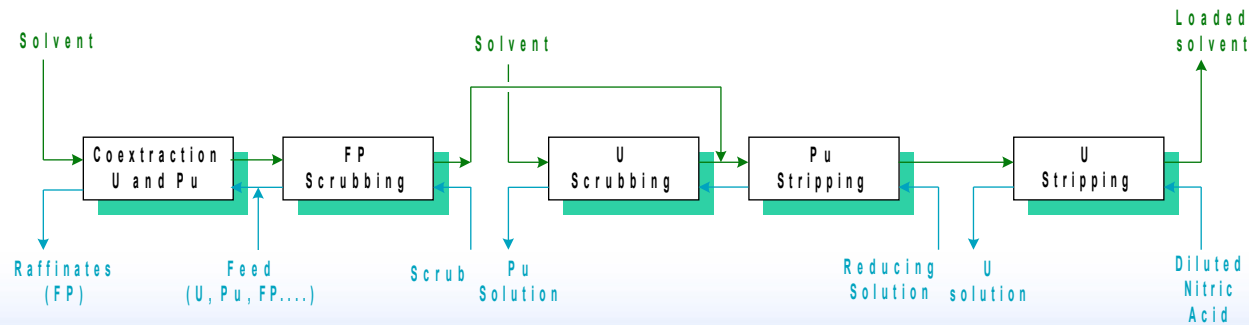

PUREX Process – Current Commercial Operating Facilities

La Hague, France



- In operation since 1976
- Capacity of about 1700 MT/yr
- Has nearly half of the world's commercial LWR reprocessing capacity
- Treats SNF from France, Japan, Germany, Belgium, Switzerland, Italy and the Netherlands
- Produces MOX which is then recycled in the Marcoule site

PUREX Process – Current Commercial Operating Facilities

THORP (Thermal Oxide Reprocessing Plant), UK



- Located at Sellafield in Cumbria, England
- In operation since 1997
- Capacity of 5 MT/day reprocessing, goal of 7000 MT in 10 yr period
- Separates U and Pu for MOX fuel
- Reprocesses SNF from outside of the U.K.

PUREX Process – Current Commercial Operating Facilities

Rokkasho, Japan



- Currently undergoing test operations. Initiated in 2006
- Capacity of 800 MT per year
- Capacity to reprocess the SNF produced from 40 reactors (1,000 MW). This is nearly 80% of the annual spent fuel generation in Japan.

Example of Separation Processes That May Be Utilized For Spent Nuclear Fuel Processing

- PUREX
- TRUEX
- DIAMEX
- SREX
- CCD-PEG
- FPEX
- UNEX
- TALSPEAK
- SANEX
- Am+6/TBP

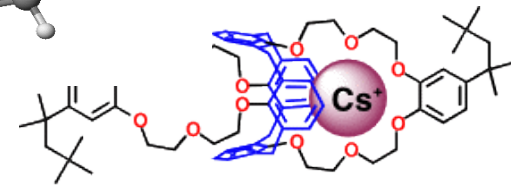
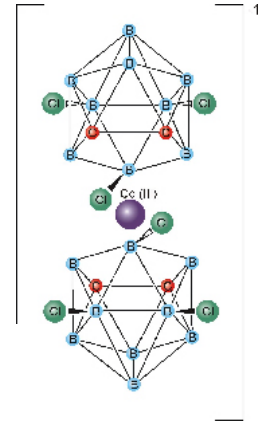
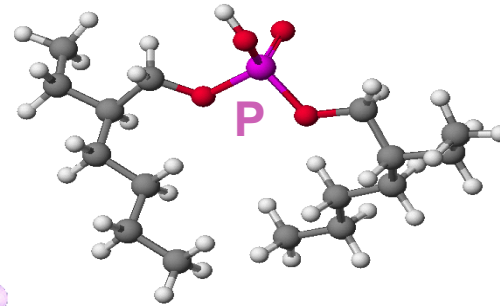
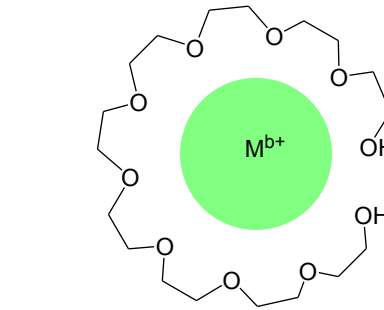
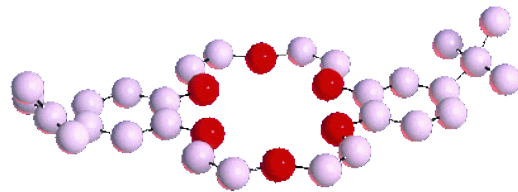
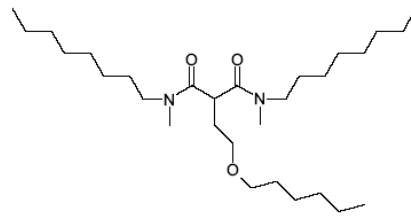
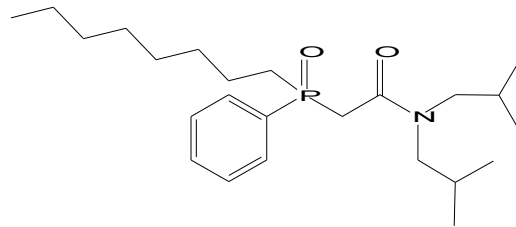

Solvent Extraction Equipment Requirements in Nuclear Fuel Cycle

- Handle a high throughput
 - Operate at wide variety of flowrates and temperatures
 - Operate in highly radioactive environment
 - Be remotely operable and maintainable
 - Operate efficiently
 - Handle solids
-

3 primary types of contactors used in the nuclear industry:

- Mixer-Settler
- Column (Packed or Pulsed)
- Centrifugal Contactor

Mixer-Settlers

- A mixer-settler consists of a first section that *mixes* the phases together followed by a quiescent *settling* section that allows the phases to separate by gravity
- The mixing impeller also provides pumping of the solutions

- Have been used for nuclear applications at Savannah River Site in the U.S., and in Europe and Asia.

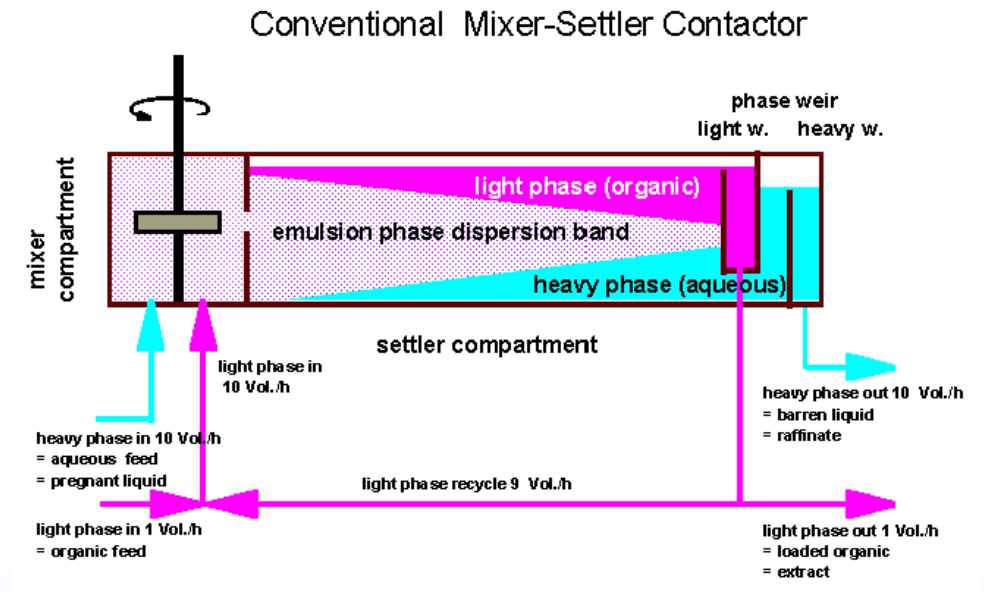

Mixer-Settler Attributes

- **Discrete stage units (with efficiencies < 1)**
- **Low capital cost**
- **Offer a wide range of capacities and simple operation**
- **Limited instrumentation required**
- **Requires large amount of floor space (but low headroom)**
- **Large solvent inventory**
- **Long residence times for processes with slow kinetics -results in increased solvent degradation**
- **Geometrically safe design has limited capacity**

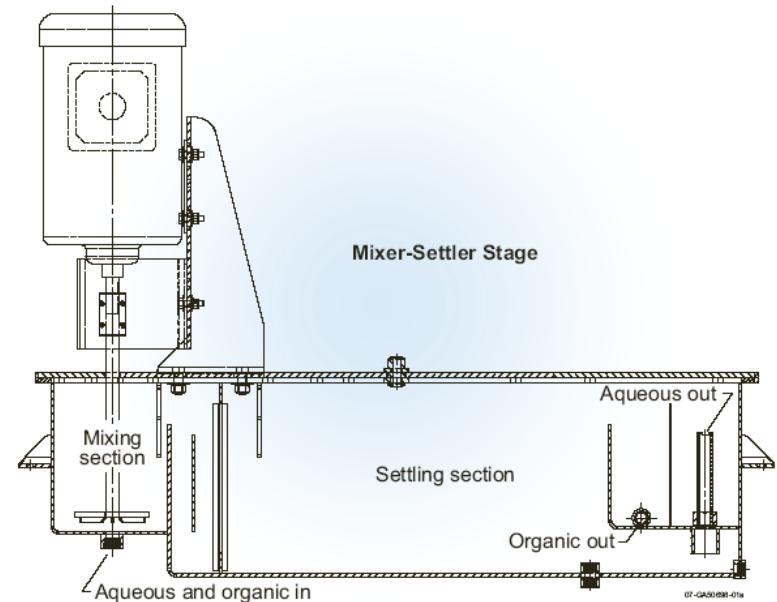

Mixer-Settler Control Requirements

- **Mixer speed**
- **Interface in settling chamber is controlled by overflow weir for the light phase and underflow weir for heavy phase**
 - **Weir system may be adjustable on lab scale units but typically fixed in production equipment**

Quinn Mixer-Settlers at INL – 1.5 LPM Capacity



Columns

- **Unlike mixer-settlers, columns are contactors without individual extraction stages.**
- **Continuous contactors - a column is equivalent in work terms to several theoretical countercurrent stages.**
- **Columns have been used extensively at Hanford, the INL, and in the UK, France, and Japan, primarily for the PUREX process.**
- **Typical columns are 30-40 feet high and provide 5-7 stages of separation per column, dependant upon flowsheet.**

Columns

- **Two types of columns employed industrially**
 - **Packed columns**
 - **Filled with packing material, such as Raschig Rings, to create a tortuous path for the two solutions as they flow through the column ensuring that the two phases are in constant contact.**
 - **Not very efficient**
 - **Large height required to achieve one theoretical stage**
 - **Pulse columns**
 - **Trays or perforated plates are used for mixing and mechanical energy (pulsing) provided**
 - **Increased efficiency and reduced height of theoretical stage**
 - **First patent on pulse column in 1930's**

Pulse Columns Operation

- **Solvent (light phase) circulating from the bottom to top of the column, with an aqueous (heavy) phase flowing countercurrent.**
- **The aqueous phase, which disperses in droplets (organic continuous mode), is immiscible with the solvent.**
- **Liquids are moved back and forth with a pulser to create turbulence as they encounter trays.**
- **Can also operate by dispersing the organic phase in the aqueous phase (aqueous continuous mode).**
- **Phases separate in disengaging heads**
- **Pulse frequency and amplitude are adjustable to achieve desired mixing.**

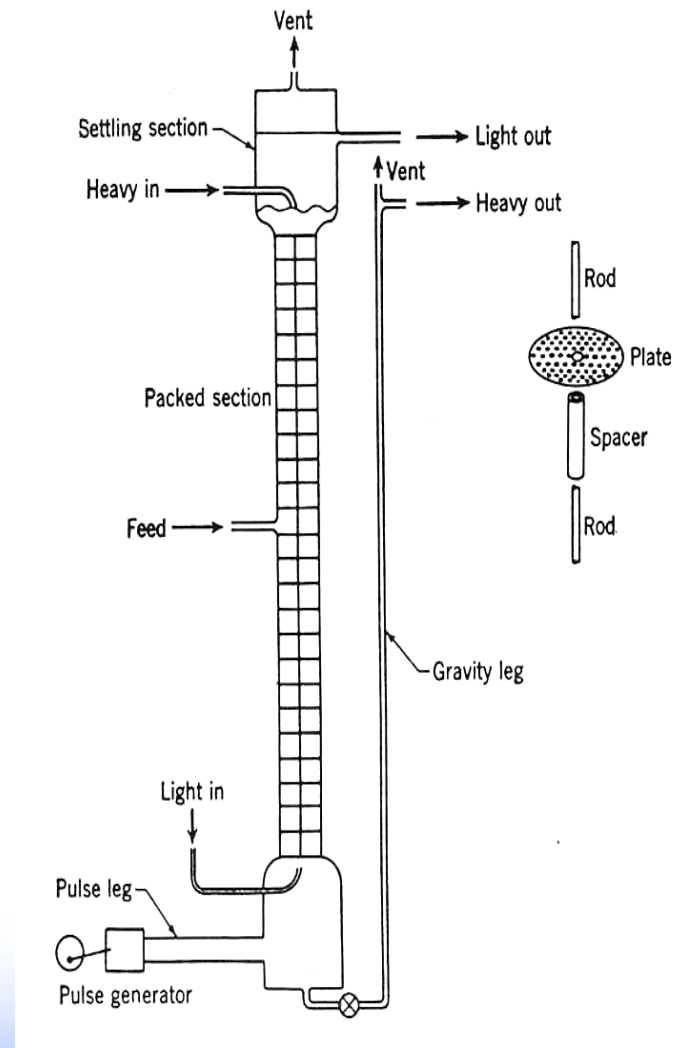

Pulse Column Attributes

- Several feet of column needed for one theoretical stage
- Low capital cost
- No moving parts required in cell
- Requires large amount of head space (40-50'), but little floor space
- Moderate solvent inventory
- Variable residence times

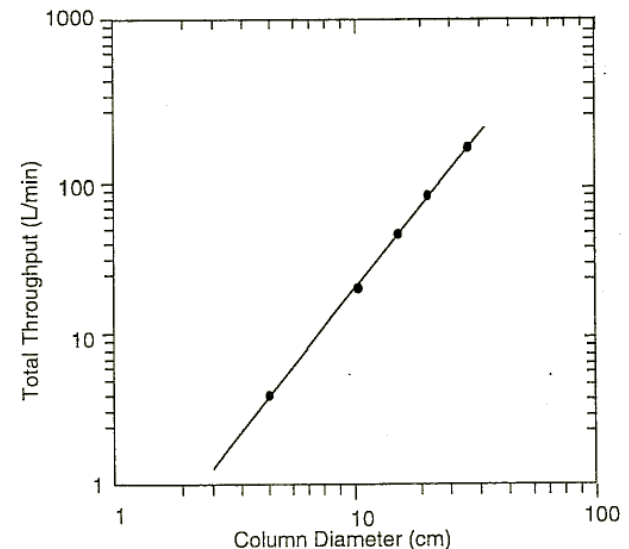

Pulse Columns

- Pulse columns at La Hague UP3 and Marcoule and INL

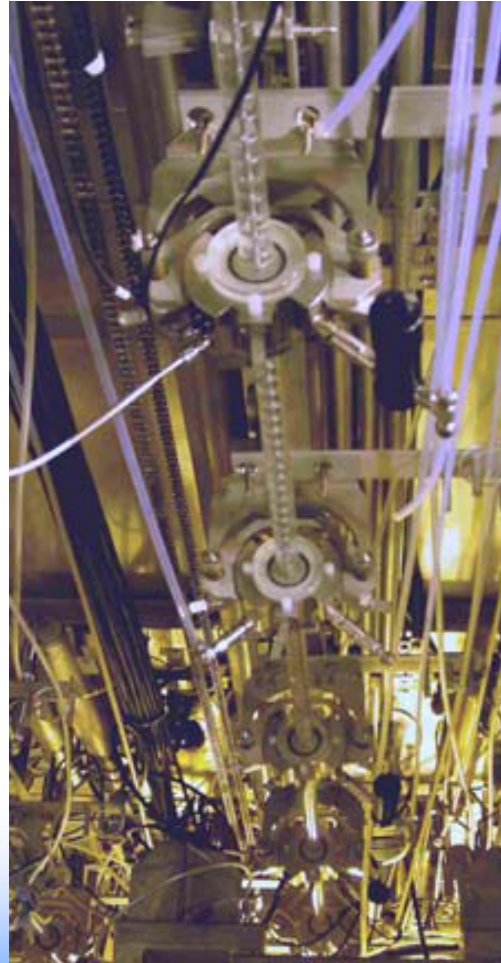

Pulse Column Types

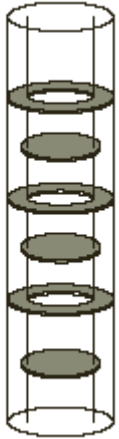

Disk and
Doughnut

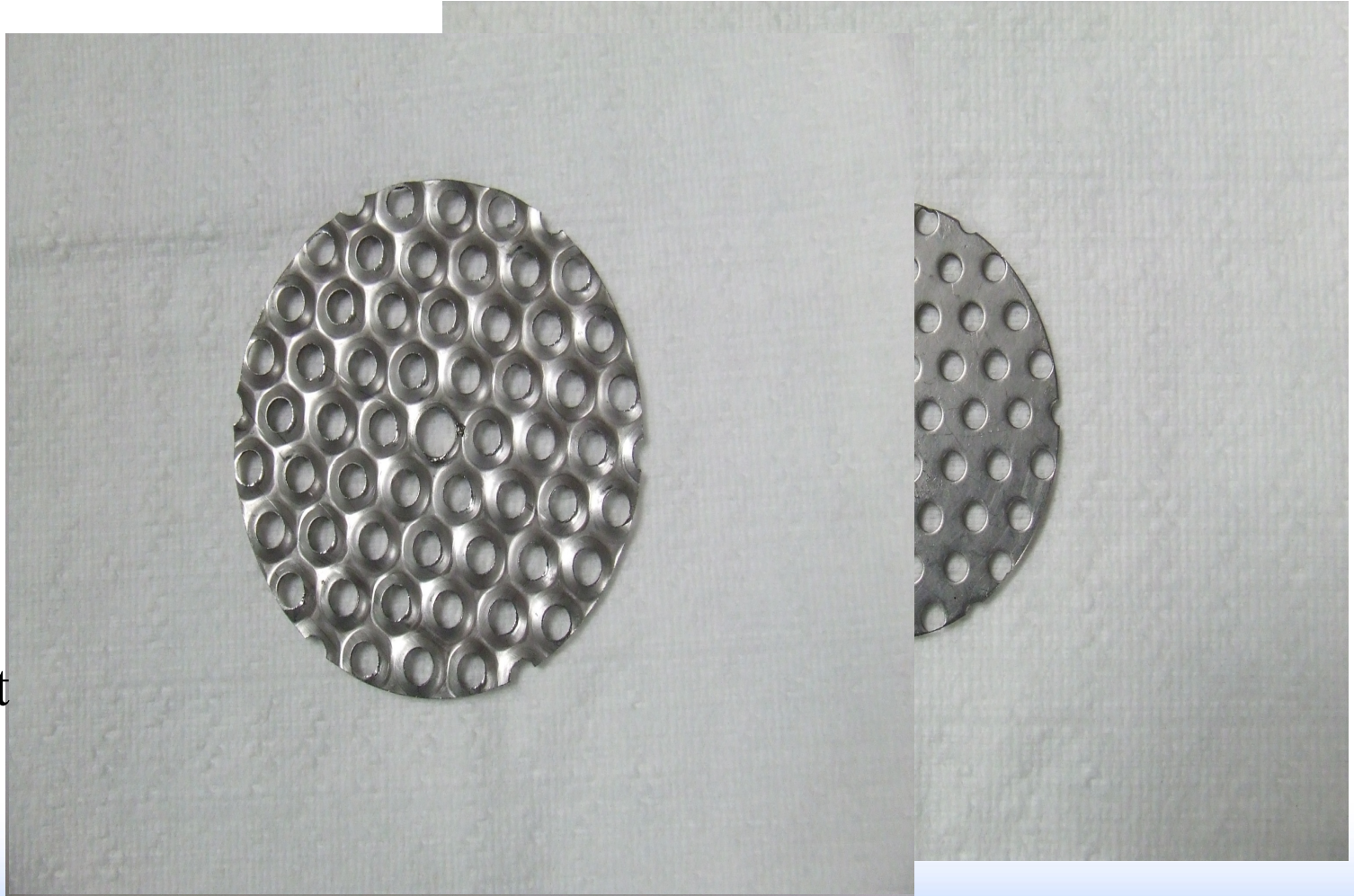

Pulsar types

- **Mechanical Pulsers**

- Mechanical devices, such as pistons, that move back and forth to displace the solution in the column
- Produce a sinusoidal wave form
- Issues with complexity, leakage past seals, and space requirements

- **Fluid-Operated Pulsers**

- Use non-compressible fluids with cam-operated bellows or incompressible fluid (air) connected to the column with a u-tube.
- All mechanical parts can be located remotely
- Several types of air pulsing devices are available: solenoid valves on pressure and vent lines, cam or air-actuated poppet valves, and rotary disk pulser

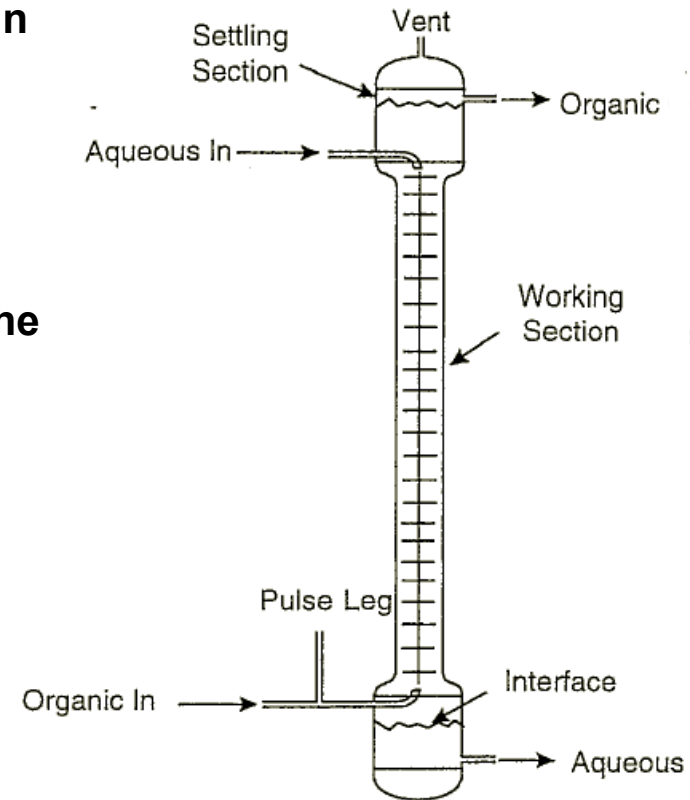

Pulse Column Control requirements

- Pulse frequency
- Pulse amplitude
- Interface control
 - Bubble probes installed in disengaging section that contains the interface
 - Fixed space between probes and pressure differential is measured to determine interface location
 - Interface location controls airlift which transfers heavy phase solution from column

Centrifugal Contactors

- Provide mixing and separating in single compact unit
- Centrifugal contactors successfully developed and operated at Savannah River Site since mid 1960's
- Annular design developed in late 1960's by ANL
- Centrifugal contactors are routinely used in the U.S., France, Russia, China, and Japan to develop solvent extraction flowsheets for advanced nuclear fuel cycles and radioactive waste treatment.
- Currently being used in France in a Pu purification cycle at La Hague
- Will be used by SRS in CSSX process (12.5-cm and 25-cm diameter)

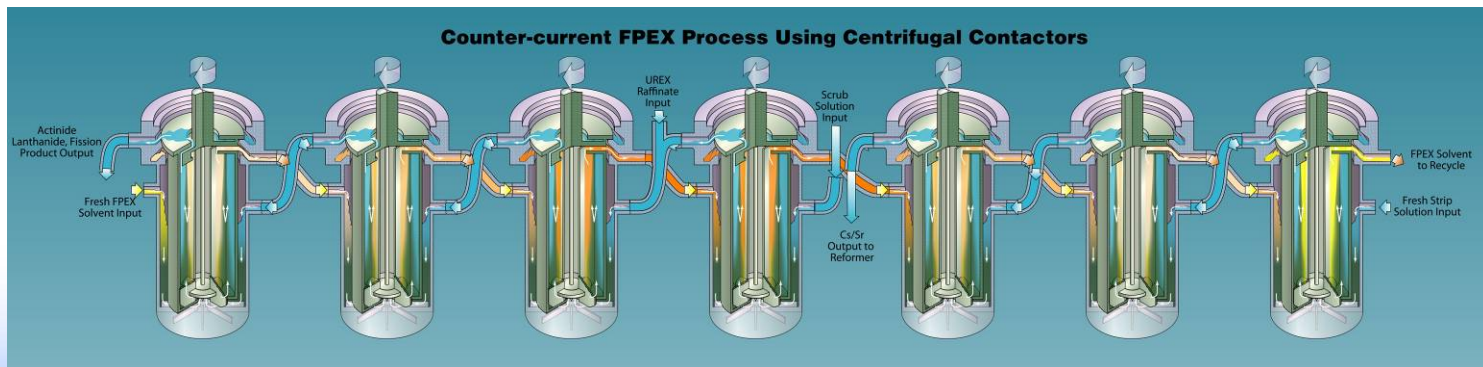

Schematics of Centrifugal Contactors

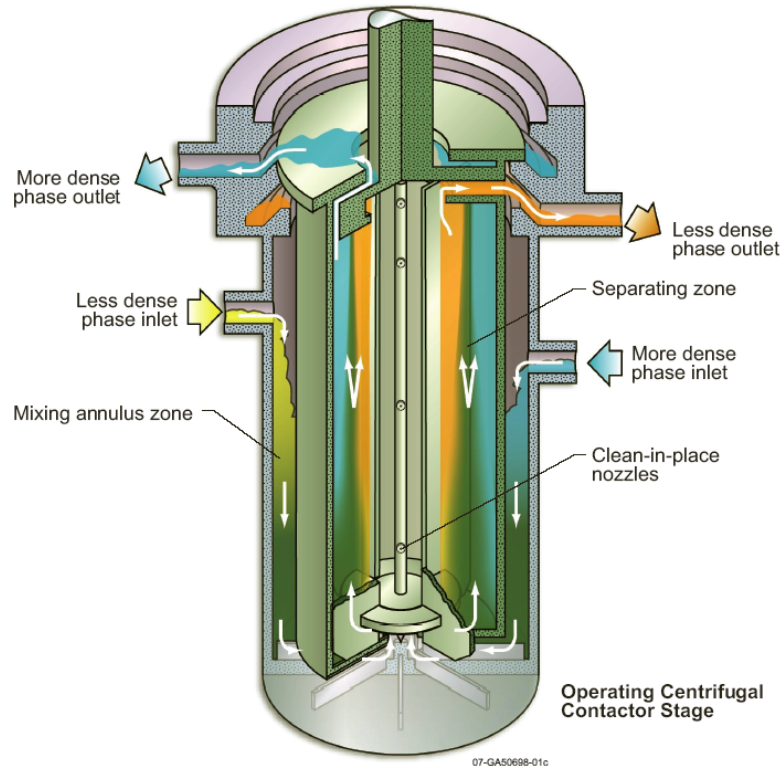

Annular Design

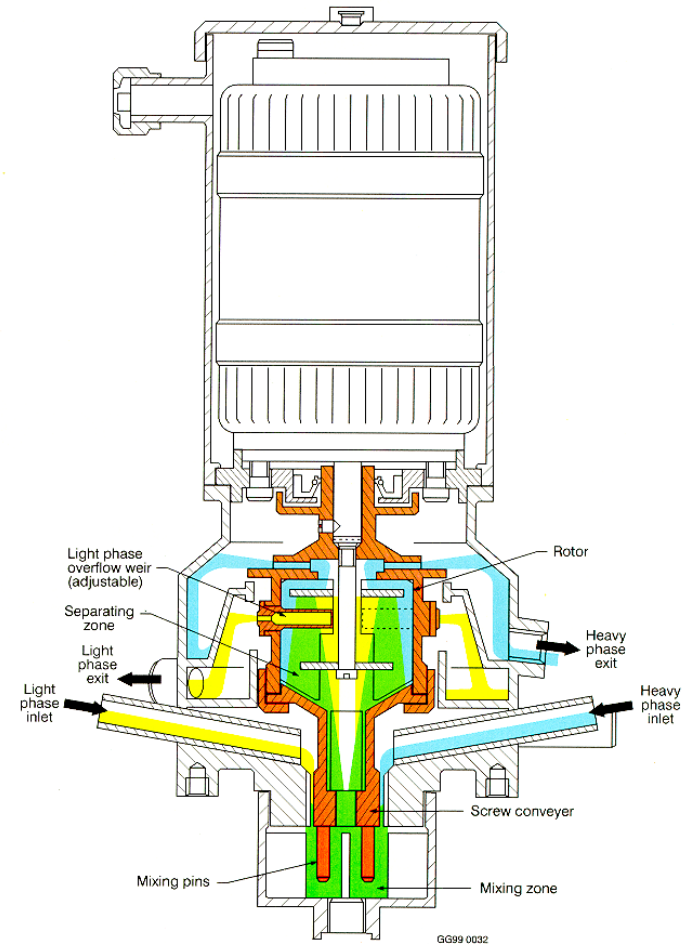

Russian Design

Centrifugal Contactor Attributes

- Discrete stage units (with efficiencies approaching 100%)
- Offer a wide range of capacities and simple operation
- Quick to reach steady-state
- Requires small amount of floor space and low headroom
- Small solvent inventory
- Short residence times resulting in reduced solvent degradation
- Remotely operable/maintainable
- Solids handling is an issue
- Requires motor in-cell



Contactor fitted with polymer housing

Centrifugal Contactor Throughput/ Residence Time

- Units sized to meet process flow requirements
 - 5 to 60 mLPM, 2-cm rotor (ANL)
 - **Laboratory scale**
 - 0.1 to 2 LPM, 5-cm rotor, (V02)
 - **Engineering scale**
 - 1 to 20 LPM, 12.5-cm rotor, (V05)
 - **Production scale**
 - 20 to 100 LPM, 25-cm rotor, (V10)
 - **Production scale**
 - 75 to 300 LPM, 40-cm rotor, (V16)
 - **Production scale**
 - 200 to 700 LPM, 50-cm rotor, (V20)
 - **Production scale**

<u>Rotor Diameter (cm)</u>	<u>Residence Time (s)</u>
5	4
12.5	6
25	10
40	13
50	15

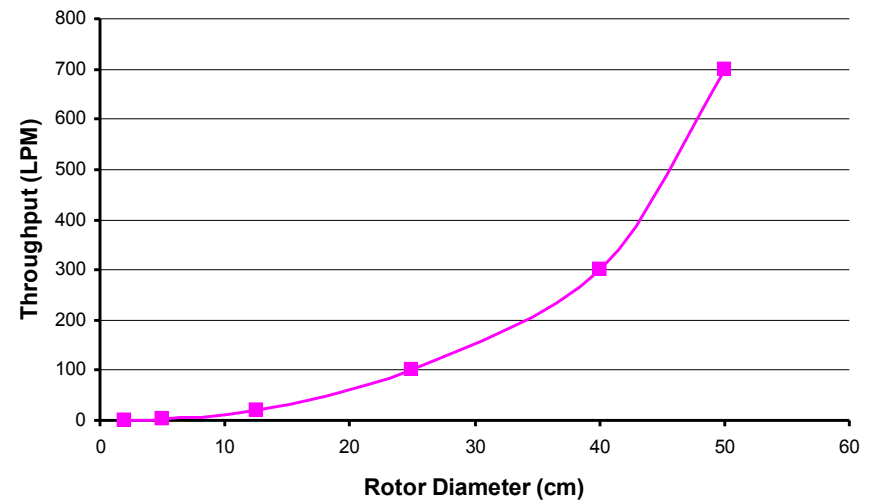

Clean-in-Place Capability

- Method to remove accumulated solids from rotor interior
- Use liquid (water or chemicals) at approximately 40 psig to spray interior of rotor through nozzles on center shaft
- Solutions drain through bottom of centrifugal contactor

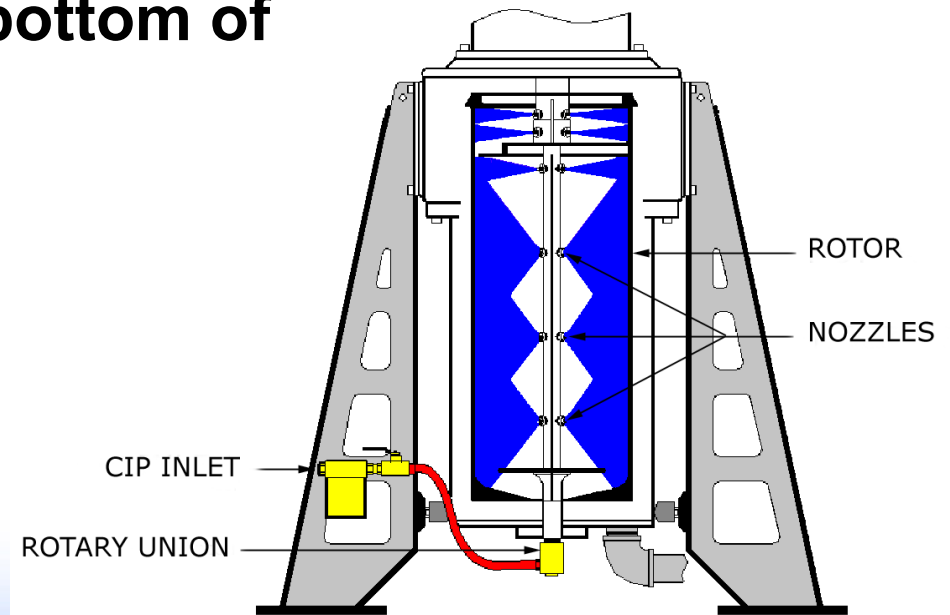
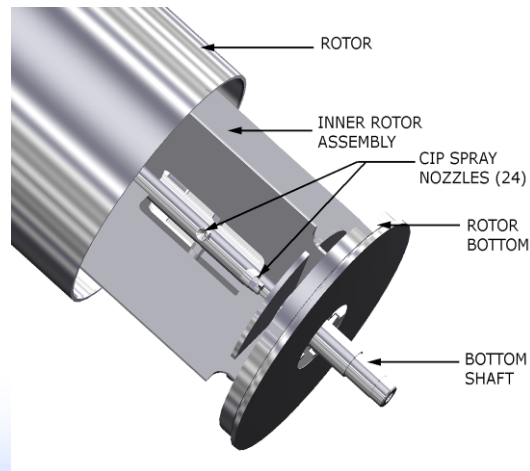

Centrifugal Contactor Control Requirements

- **Heat exchanger jackets can be included on centrifugal contactor stages to control temperature in sections of the flowsheet.**
 - **Temperature control of feed solutions likely adequate for many applications**



Contactor Comparison

Criteria	Ratings ^a			Comments
	Mixer-settler	Pulse Column	Centrifugal Contactor	
Long residence time ^b	5	4	1	
Short residence time ^c	1	2	5	
Building headroom	5	1	5	
Floor space required	1	5	3	May be small percentage of total floor area.
Instrumentation/control	5	4	5	
Ease of scale-up	3	3	5	
Low hold-up volume	2	3	5	
Equipment reliability	4	5	3	Significant commercial centrifugal contactor experience past 15 years.
Equipment capital cost	4	5	4	May be insignificant in relation to building cost.
Process flexibility ^d	4	3	5	
High throughput	2	5	5	Based on criticality safe by geometry equipment.
Ability to tolerate solids ^e	2	5	2	Assumes no centrifugal contactor CIP.
Reach steady state quickly	2	3	5	
Rapid restart	5	2	5	After temporary shutdown.

- a. 5 = superior, 4 = good, 3 = average, 2 = below average, 1 = poor.
- b. Considered an advantage when process chemistry requires long residence time.
- c. Considered an advantage when solvent degradation is a concern.
- d. Process flexibility includes such factors as the range of O/A flow ratio, the turndown in flowrate, and the ease with which the location of feed and product streams can be changed.
- e. U.S. Patent 5,908,376 "Self Cleaning Rotor for a Centrifugal Separator."

Summary

- **Mixer-settlers, pulse columns, and centrifugal contactors have been successfully used in the nuclear industry for decades**
- **Improvement in equipment design has allowed for more reliable and efficient operation**
- **The equipment types each have advantages and disadvantages**
- **To determine the appropriate equipment to use for a specific application, the following must be evaluated: criticality constraints, process (holdup) volume, process complexity (operability), reliability, maintenance philosophy, throughput, costs and performance issues such as solvent exposure (contact time), solids tolerance, flow rate turndown, equilibrium upset resistance, and process kinetics.**